



Cover 3:
Valencia Spot Natural

Cover 4:
Duchess Pearl

Cover 2:
Duchess Pearl

Cover 2:
Valencia Zig Zag Natural

Cover 4:
Duchess Pearl

Cover 3:
Valencia Spot Natural

Cover 1:
Valencia Zig Zag Natural

Cover 1:
Hamilton Beige

Antique Feet

Antique Feet

Cover 1:
Hamilton Beige

Piper Collection

Colours represented are to be used as a guide only.
Please refer to manufacturers swatch for a more accurate colour match. 11.01.2017

Please note that colour shadings can vary slightly from each roll of fabric.
We cannot guarantee a precise match to these samples or between cut lengths and upholstered goods.



Award Winning Seating Technology

02/11/2020

PIPER COVER GUIDE - FIXED BACK

Please use this guide when ordering the following pieces to clarify cover options.

4 Seater Modular Sofa (4MD)

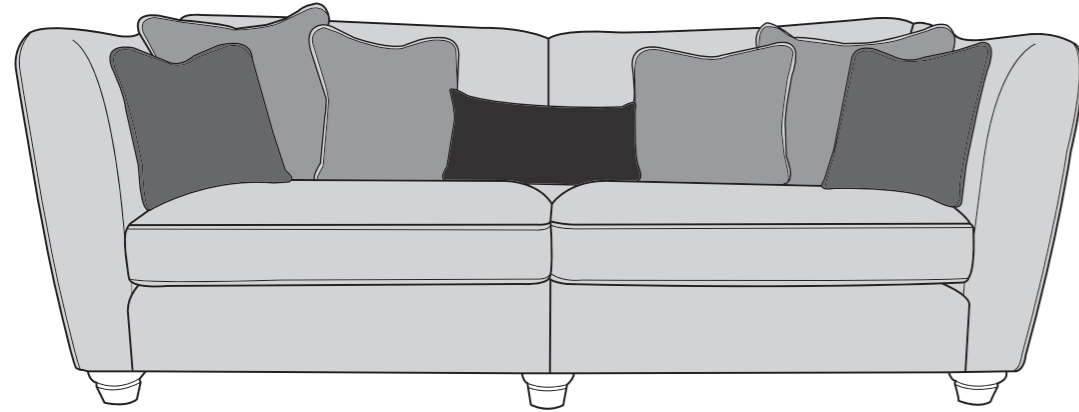

3 Seater Sofa (3ST)

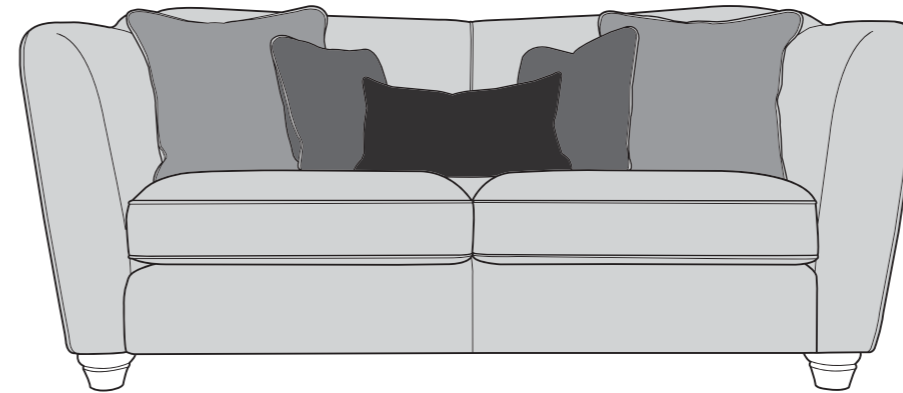

2 Seater Sofa (2ST)

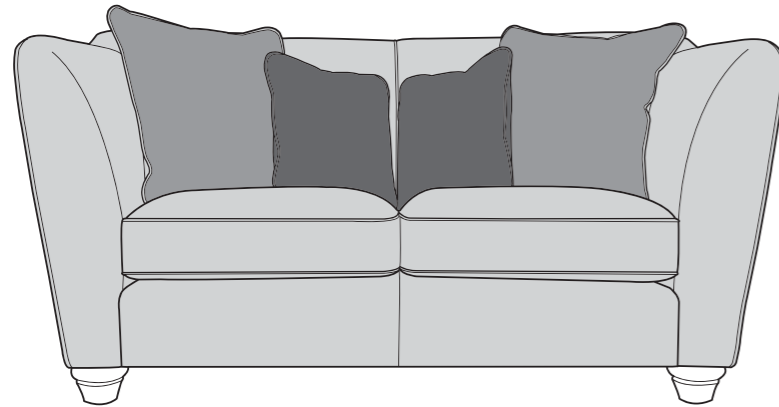

Love Chair (LOV)

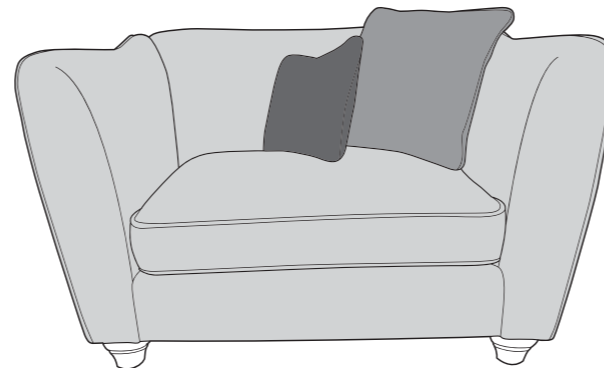

Arm Chair (1ST)

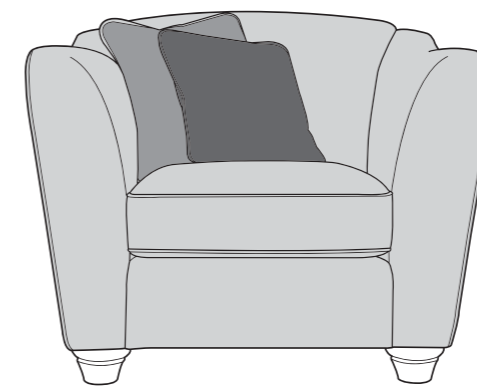

ACCENT PIECES

Piper Throne Chair (ACH)
Available in cover 1, 2, 3 or 4

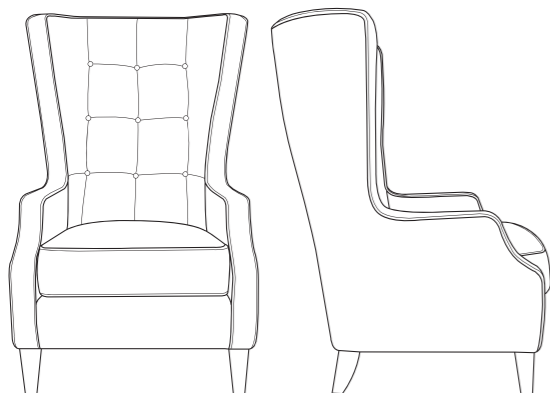



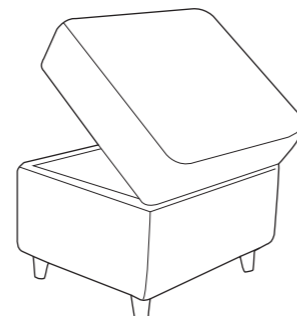

Small Storage Footstool (FSS)
Available in cover 1, 2, 3 or 4

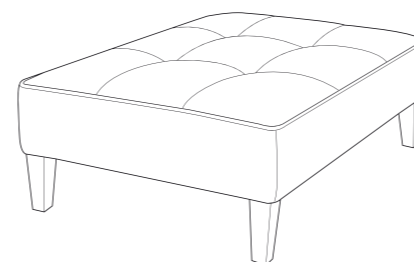

Buttomed Footstool (FST)
Available in cover 1, 2, 3 or 4



-  **COVER 1**
(BODY)
-  **COVER 2**
(SCATTER)
-  **COVER 3**
(SCATTER)
-  **COVER 4**
(BOLSTER)

Large & Medium Scatter Cushions

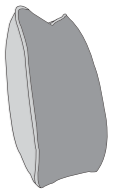

Front = Cover 2
Piping = Cover 1
Reverse = Cover 1

Small Scatter Cushions



Front = Cover 3
Piping = Cover 3
Reverse = Cover 3

Bolster



Front = Cover 4
Reverse = Cover 4

(Included in 4 & 3 Seater Sofas)

Feather Filled
Scatters & Bolster



APPROVED MEMBER



PIPER DIMENSIONS (CM)

AVAILABLE PIECES	HEIGHT 1	WIDTH 2	DEPTH 3	SEAT HEIGHT 4	SEAT DEPTH (STD) 5	SEAT WIDTH 6	ACCESS DIAGONAL 7	WEIGHT (KG)	SCATTER CUSHIONS
4 SEATER MODULAR SOFA	90	242	99	52	69	196	260	87	6 + 1 BOLSTER
LFS/RFS UNIT	90	121	99	52	69	98	N/A	87	3
3 SEATER SOFA	90	211	99	52	69	165	229	71	5
2 SEATER SOFA	90	182	99	52	69	134	202	63.5	4
LOVE CHAIR	90	145	99	52	69	97	127	60	2
ARM CHAIR	86	107	99	52	69	63	140	44	2
ACCENT PIECES									
PIPER THRONE CHAIR	122	73	88	52	54	55	102	28.5	N/A
SMALL STORAGE FOOTSTOOL	45	63	50	N/A	N/A	N/A	75	12.5	N/A
ACCENT FOOTSTOOL	37	104	73	N/A	N/A	N/A	123	12	N/A



- * Hardwood & composite board frame.
- * Dowelled, screwed, glued & stapled joinery.
- * Available with dark or light wood feet.

- * 4 seater modular sofa delivered as 2 units (LFS & RFS) for ease of delivery.
- * Award winning foamflex seat interior with 5 year guarantee.
- * Feather filled scatter cushions & bolster included for added luxury.



- * Bolt on sofa arms for ease of delivery.
- * Serpentine seat springs & silent wire.
- * Superloop back springs.

DIMENSION GUIDE

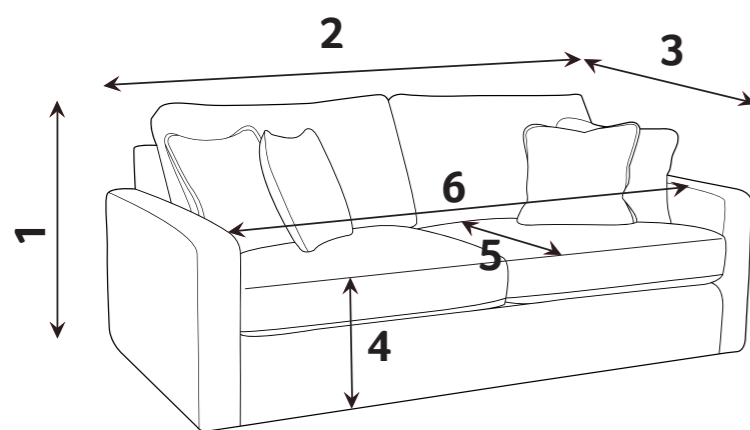

- 1 - HEIGHT
- 2 - WIDTH
- 3 - DEPTH
- 4 - SEAT HEIGHT
- 5 - SEAT DEPTH (STD & PILLOW)
- 6 - SEAT WIDTH
- 7 - DIAGONAL ACCESS

Check the diagonal access dimension to ensure furniture will fit in your home.

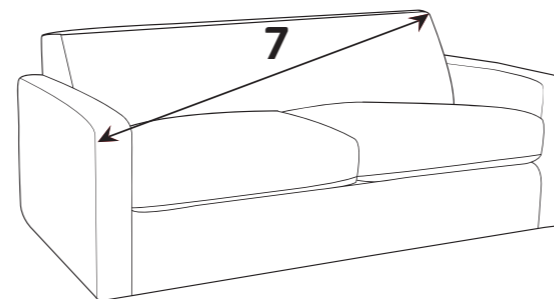

Illustrations used for reference only.

foamflex™

Our new expertly engineered foam seat interior gives you the comfort of fibre with the retention of foam.

CARE GUIDE

To improve the longevity of your hand-made furniture, we recommend rotating cushions (where applicable).

For further information on maintaining your furniture, please refer to the Care Guide located under the seat platform.



Our foamflex seat interiors have been granted the FIRA GOLD Award, a mark of quality under-pinning all necessary testing of the product materials, design and production techniques.

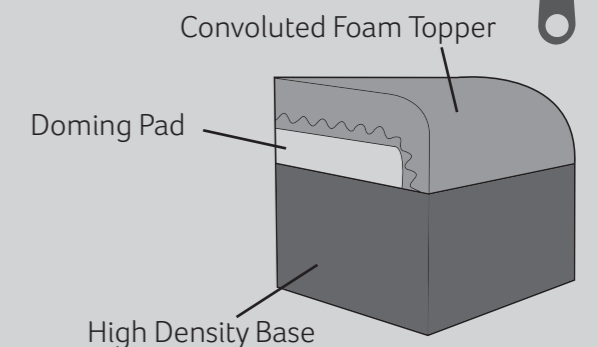

FOOT OPTIONS:



Please note : All dimensions are approximate. Allow tolerance of +/- 2.5cm.

Wood is a natural product and will vary in shade/colour from item to item. Feet may require fitting.

